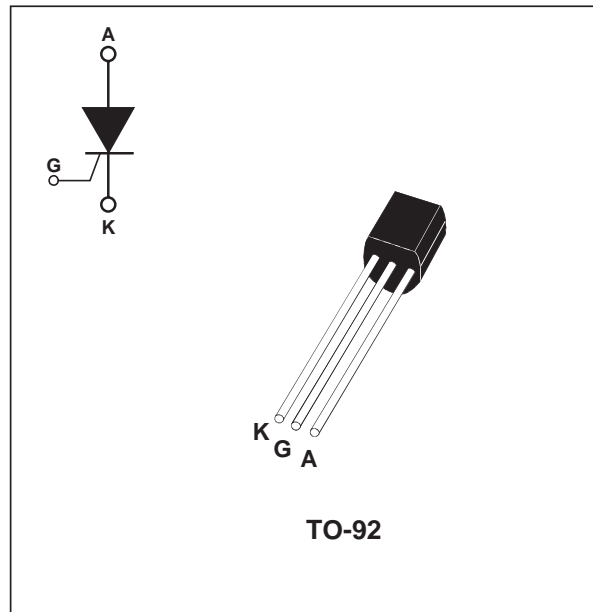

SENSITIVE GATE 0.8A SCR_s
MAIN FEATURES

Symbol	Value	Unit
$I_{T(RMS)}$	0.8	A
V_{DRM}	400	V
I_{GT}	200	μA

DESCRIPTION

Thanks to its highly sensitive triggering levels, the XL0840 device is suitable for all high volumes applications where the available gate current is limited, such as Christmas lights control.

ABSOLUTE RATINGS (limiting values)

Symbol	Parameter		Value	Unit
$I_{T(RMS)}$	RMS on-state current (180° conduction angle)		$T_I = 55^\circ C$ 0.8	A
$I_{T(AV)}$	Average on-state current (180° conduction angle)		$T_I = 55^\circ C$ 0.5	A
I_{TSM}	Non repetitive surge peak on-state current	$t_p = 8.3 \text{ ms}$	$T_j = 25^\circ C$ 8	A
		$t_p = 10 \text{ ms}$		
I^2t	I^2t Value for fusing	$t_p = 10 \text{ ms}$	$T_j = 25^\circ C$ 0.24	A^2s
di/dt	Critical rate of rise of on-state current $I_G = 2 \times I_{GT}$, $t_r \leq 100ns$	$F = 60 \text{ Hz}$	$T_j = 125^\circ C$ 30	$A/\mu s$
I_{GM}	Peak gate current	$t_p = 20\mu s$	$T_j = 125^\circ C$ 1	A
$P_{G(AV)}$	Average gate power dissipation		$T_j = 125^\circ C$ 0.1	W
T_{stg} T_j	Storage junction temperature range Operating junction temperature range		- 40 to + 150 - 40 to + 125	$^\circ C$

XL0840

ELECTRICAL CHARACTERISTICS (T_j = 25°C, unless otherwise specified)

Symbol	Test Conditions		XL0840	Unit		
I _{GT}	V _D =12V R _L =140Ω		MAX.	200	μA	
V _{GT}			MAX.	0.8	V	
V _{GD}	V _D =V _{DRM} R _L =3.3kΩ R _{GK} = 1kΩ	T _j = 125°C	MIN.	0.1	V	
V _{RG}	I _{RG} = 10μA		MIN.	8	V	
I _H	I _T = 50mA R _{GK} = 1kΩ		MAX.	5	mA	
I _L	I _G = 1mA R _{GK} = 1kΩ		MAX.	6	mA	
dV/dt	V _D =67% V _{DRM} R _{GK} = 1kΩ	T _j = 125°C	MIN.	75	V/μs	
V _{TM}	I _{TM} = 1.6A tp = 380μs	T _j = 25°C	MAX.	1.95	V	
V _{TO}	Threshold voltage		T _j = 125°C	MAX.	1.0	V
R _d	Dynamic resistance		T _j = 125°C	MAX.	600	mΩ
I _{DRM}	V _{DRM} R _{GK} = 1kΩ	T _j = 25°C	MAX.	1	μA	
		T _j = 125°C		100		

THERMAL RESISTANCES

Symbol	Parameter	Value	Unit
R _{th(j-a)}	Junction to ambient (DC)	150	°C/W
R _{th(j-l)}	Junction to lead (DC)	80	°C/W

PRODUCT SELECTOR

Part Number	Voltage	Sensitivity	Package
XL0840	400V	200 μA	TO-92

ORDERING INFORMATION

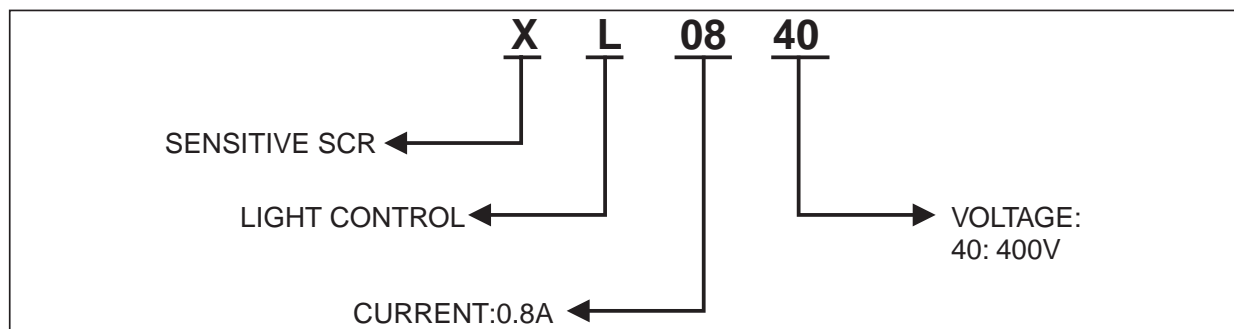

OTHER INFORMATION

Part Number	Marking	Weight	Base quantity	Packing mode
XL0840	XL0840	0.2 g	2500	Bulk

Fig. 1: Maximum average power dissipation versus average on-state current.

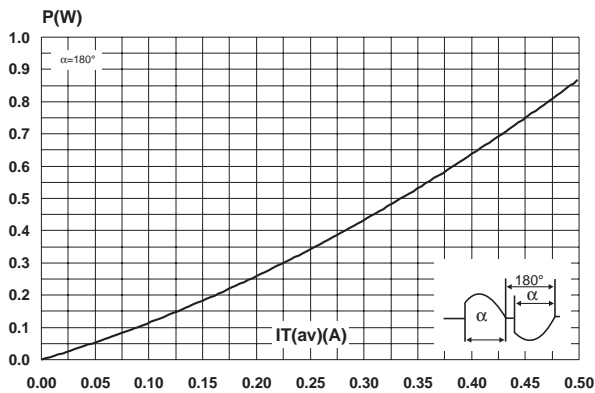

Fig. 2-1: Average and D.C. on-state current versus lead temperature.

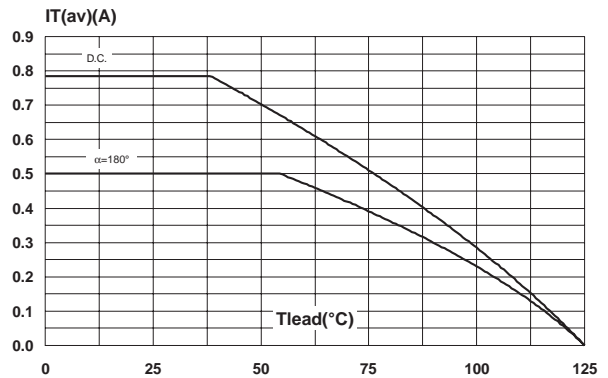

Fig. 2-2: Average and D.C. on-state current versus ambient temperature (device mounted on FR4 with recommended pad layout).

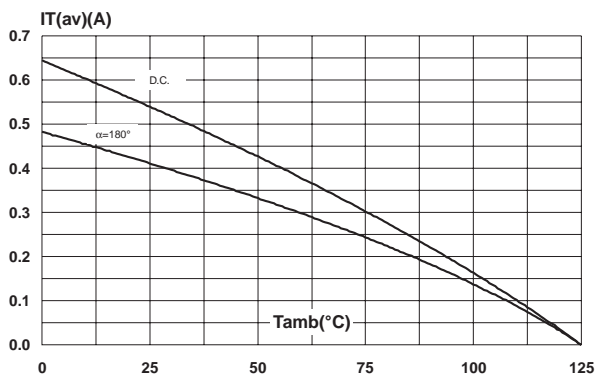

Fig. 3: Relative variation of thermal impedance junction to ambient versus pulse duration.

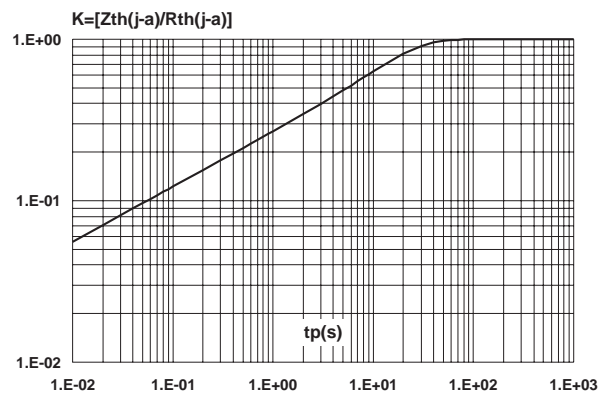

Fig. 4: Relative variation of gate trigger current, holding current and latching current versus junction temperature (typical values).

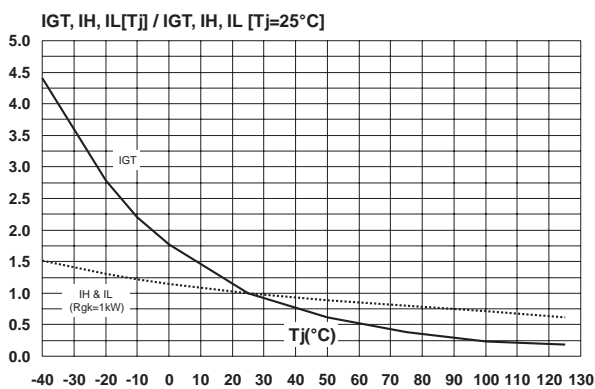

Fig. 5: Relative variation of holding current versus gate-cathode resistance (typical values).

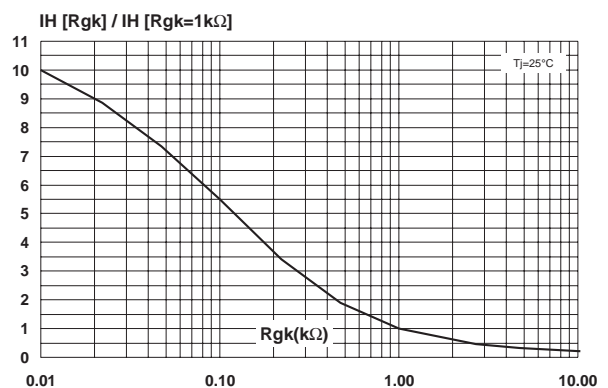

Fig. 6: Relative variation of dV/dt immunity versus gate-cathode resistance (typical values).

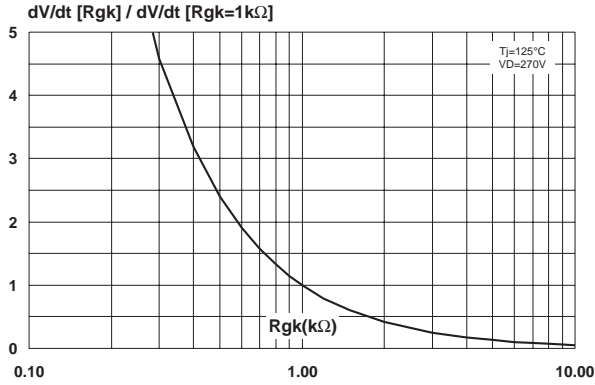

Fig. 7: Relative variation of dV/dt immunity versus gate-cathode capacitance (typical values).

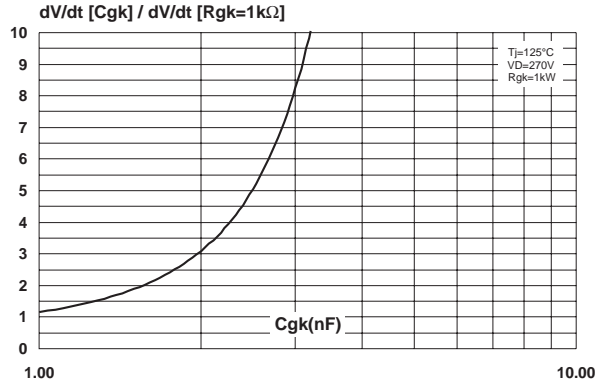

Fig. 8: Surge peak on-state current versus number of cycles.

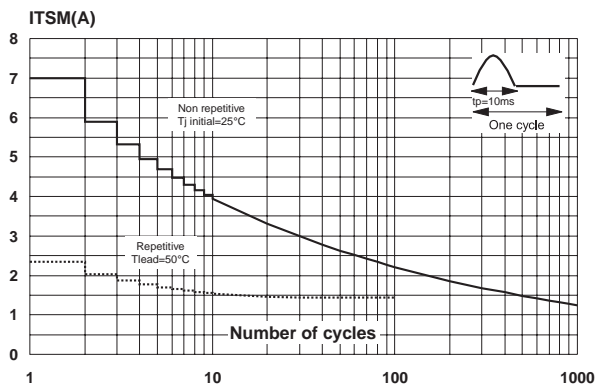

Fig. 9: Non repetitive surge peak on-state current for a sinusoidal pulse with width $t_p < 10ms$, and corresponding value of I^2t .

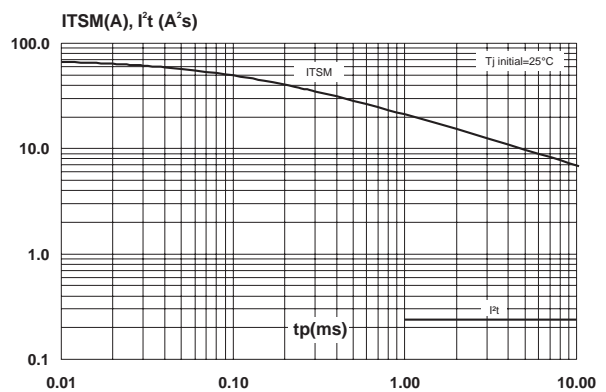
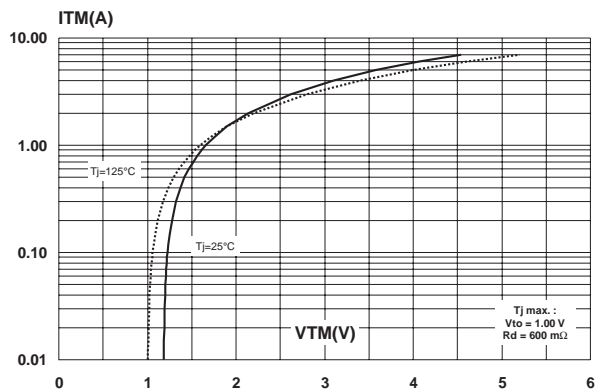
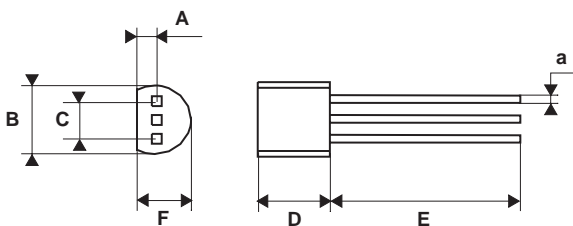

Fig. 10: On-state characteristics (maximum values).



PACKAGE MECHANICAL DATA

TO-92



REF.	DIMENSIONS					
	Millimeters			Inches		
	Min.	Typ.	Max.	Min.	Typ.	Max.
A		1.35			0.053	
B			4.70			0.185
C		2.54			0.100	
D	4.40			0.173		
E	12.70			0.500		
F			3.70			0.146
a			0.50			0.019

Information furnished is believed to be accurate and reliable. However, STMicroelectronics assumes no responsibility for the consequences of use of such information nor for any infringement of patents or other rights of third parties which may result from its use. No license is granted by implication or otherwise under any patent or patent rights of STMicroelectronics. Specifications mentioned in this publication are subject to change without notice. This publication supersedes and replaces all information previously supplied. STMicroelectronics products are not authorized for use as critical components in life support devices or systems without express written approval of STMicroelectronics.

The ST logo is a registered trademark of STMicroelectronics

© 2002 STMicroelectronics - Printed in Italy - All rights reserved.

STMicroelectronics GROUP OF COMPANIES

Australia - Brazil - Canada - China - Finland - France - Germany
 Hong Kong - India - Israel - Italy - Japan - Malaysia - Malta - Morocco - Singapore
 Spain - Sweden - Switzerland - United Kingdom - United States.

<http://www.st.com>