

FEATURES

- **LOW COST PLASTIC SURFACE MOUNT PACKAGE**
Available on Tape and Reel
- **USABLE TO 3.7 GHz:**
Fixed Wireless Access, ISM, WLL, MMDS, IMT-2000, PCS
- **HIGH OUTPUT POWER:**
30 dBm TYP with 5.0 V Vdc
27 dBm TYP with 3.5 V Vdc
- **HIGH LINEAR GAIN:**
12 dB TYP at 1.9 GHz
- **LOW THERMAL RESISTANCE:**
30°C/W

DESCRIPTION

NEC's NE651R479A is a GaAs HJ-FET designed for medium power mobile communications, Fixed Wireless Access, ISM, WLL, PCS, IMT-2000, and MMDS transmitter and subscriber applications. It is capable of delivering 0.5 Watts of output power (CW) at 3.5 V, and 1 Watt of output power (CW) at 5 V with high linear gain, high efficiency, and excellent linearity. Reliability and performance uniformity are assured by NEC's stringent quality and control procedures.

OUTLINE DIMENSIONS (Units in mm)

PACKAGE OUTLINE 79A

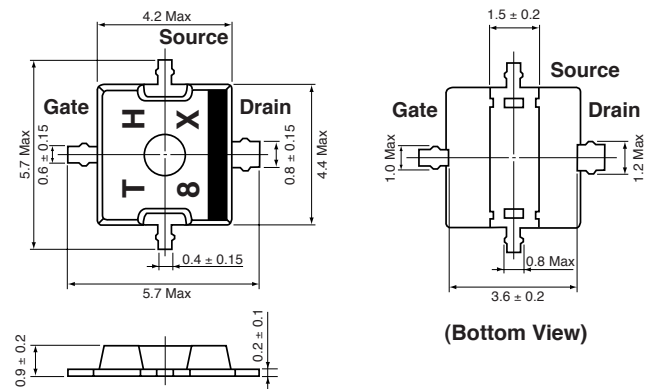

TYPICAL 5 V RF PERFORMANCE FOR REFERENCE (NOT SPECIFIED) (T_c = 25°C)

SYMBOLS	CHARACTERISTICS	UNITS	MIN	TYP	MAX	TEST CONDITIONS
P _{OUT}	Output Power	dBm		29.5		f = 1.9 GHz, V _{DS} = 5 V P _{IN} = +15 dBm, R _G = 1 k Ω, I _{DSQ} = 50 mA (RF OFF)
GL	Linear Gain ¹	dB		12.0		
η _{ADD}	Power Added Efficiency	%		58		
I _D	Drain Current	mA		350		

Note:

1. P_{IN} = 0 dBm.

ELECTRICAL CHARACTERISTICS (T_c = 25°C)

PART NUMBER			NE651R479A			TEST CONDITIONS
PACKAGE OUTLINE			79A			
SYMBOLS	CHARACTERISTICS	UNITS	MIN	TYP	MAX	
P _{OUT}	Output Power	dBm	26.0	27.0		f = 1.9 GHz, V _{DS} = 3.5 V P _{IN} = +15 dBm, R _G = 1 k Ω, I _{DSQ} = 50 mA (RF OFF) ²
GL	Linear Gain ¹	dB		12.0		
η _{ADD}	Power Added Efficiency	%	52	60		
I _D	Drain Current	mA		220		
I _{DSS}	Saturated Drain Current	A		0.7		V _{DS} = 2.5 V, V _{GS} = 0 V
V _P	Pinch-Off Voltage	V	-2.0		-0.4	V _{DS} = 2.5 V, I _D = 14 mA
BV _{GD}	Gate to Drain Break Down Voltage	V	12			I _{GD} = 14 mA
R _{TH}	Thermal Resistance, Channel to Case	°C/W		30	50	

Notes:

1. P_{IN} = 0 dBm.
2. DC performance is 100% tested. Wafers are sample tested for RF performance. Wafer rejection criteria for standard devices is 1 reject for sample lot.

TYPICAL 3.5 V RF PERFORMANCE FOR REFERENCE (NOT SPECIFIED) ($T_c = 25^\circ\text{C}$)

SYMBOLS	CHARACTERISTICS	UNITS	MIN	TYP	MAX	TEST CONDITIONS
P_{OUT}	Output Power	dBm		27.0		f = 900 MHz, $V_{DS} = 3.5$ V $P_{IN} = +13$ dBm, $R_G = 1$ k Ω , $I_{DSQ} = 50$ mA (RF OFF)
GL	Linear Gain ¹	dB		14.0		
η_{ADD}	Power Added Efficiency	%		60		
I_D	Drain Current	mA		230		

ABSOLUTE MAXIMUM RATINGS¹ ($T_A = 25^\circ\text{C}$)

SYMBOLS	PARAMETERS	UNITS	RATINGS
V_{DS}	Drain to Source Voltage	V	8
V_{GS}	Gate to Source Voltage	V	-4
I_{DS}	Drain Current	A	1.0
I_{GF}	Gate Forward Current	mA	10
I_{GR}	Gate Reverse Current	mA	10
P_T	Total Power Dissipation ²	W	2.5
T_{CH}	Channel Temperature	$^\circ\text{C}$	150
T_{STG}	Storage Temperature	$^\circ\text{C}$	-65 to +150

Notes:

- Operation in excess of any one of these parameters may result in permanent damage.
- Mounted on a 50 x 50 x 1.6 mm double copper clad epoxy glass PWB. $T_A = +85^\circ\text{C}$

RECOMMENDED OPERATING LIMITS

SYMBOL	PARAMETER	UNITS	MIN	TYP	MAX
V_{DS}	Drain to Source Voltage	V		3.5	6.0
GCOMP	Gain Compression ¹	dB			3.0
T_{CH}	Channel Temperature	$^\circ\text{C}$			+125

Note:

- Recommended maximum gain compression is 3.0 dB at $V_{DS} = 4.2$ to 5.5 V.

ORDERING INFORMATION

PART NUMBER	QTY
NE651R479A-T1-A	1 kpcs/Reel
NE651R479A-A	Bulk, 100 Pcs. Min.

Note:

- Embossed Tape, 12 mm wide.

TYPICAL PERFORMANCE CURVES ($T_A = 25^\circ\text{C}$)

TRANSCONDUCTANCE AND DRAIN CURRENT vs. GATE VOLTAGE

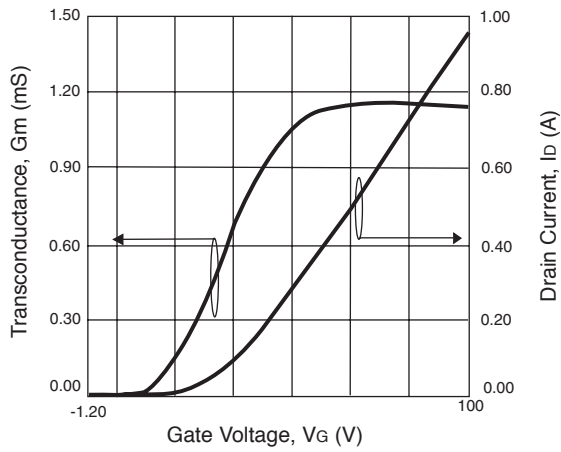

TOTAL POWER DISSIPATION vs. CASE TEMPERATURE

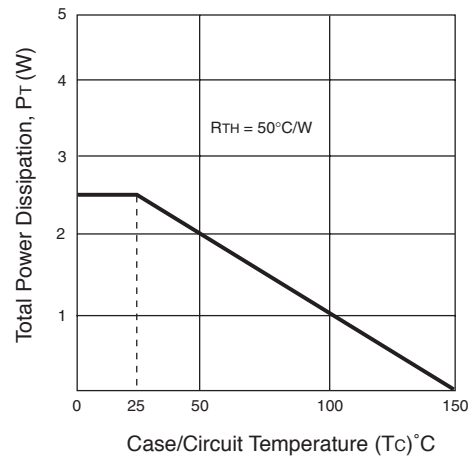

DRAIN CURRENT vs. DRAIN VOLTAGE

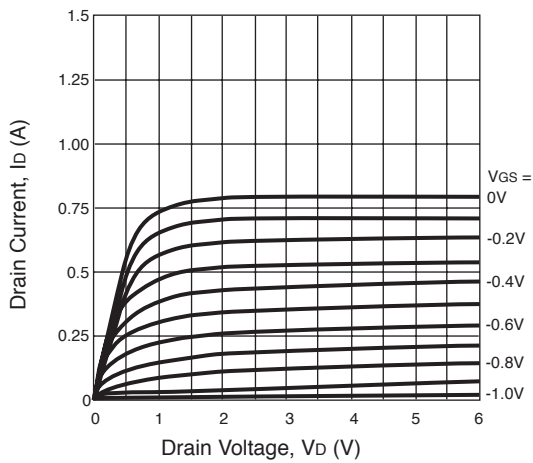

MAXIMUM AVAILABLE GAIN vs. FREQUENCY

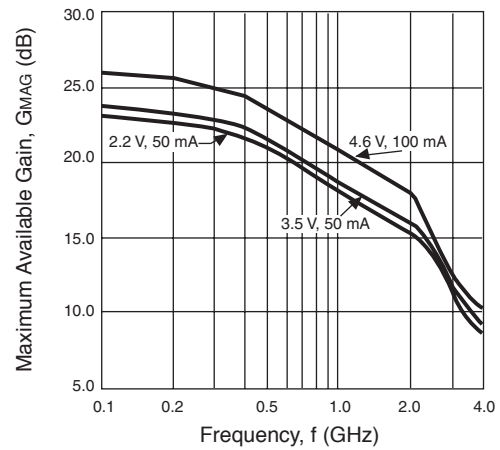

TYPICAL SCATTERING PARAMETERS (T_A = 25°C)

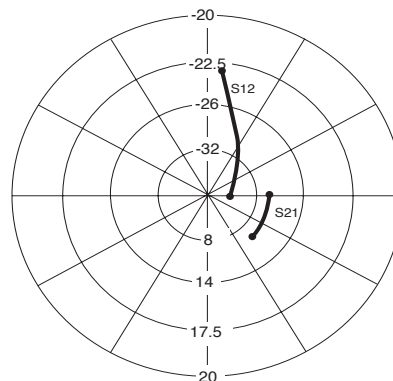
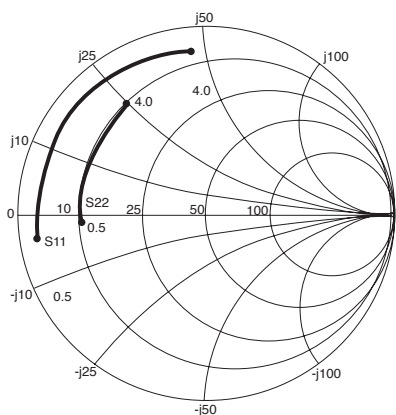

Coordinates in Ohms
Frequency in GHz
V_D = 5 V, I_D = 100 mA

V_D = 5 V, I_D = 100 mA

FREQUENCY GHz	S ₁₁		S ₂₁		S ₁₂		S ₂₂		K	MAG ¹ (dB)
	MAG	ANG	MAG	ANG	MAG	ANG	MAG	ANG		
0.50	0.905	-171.35	7.390	85.67	0.031	3.68	0.664	-178.52	0.22	23.77
0.60	0.905	-176.45	6.174	81.57	0.031	1.08	0.667	178.06	0.26	22.99
0.70	0.904	179.28	5.310	77.91	0.031	-0.70	0.669	175.09	0.31	22.34
0.80	0.904	172.25	4.650	74.54	0.031	-2.57	0.669	172.45	0.36	21.76
0.90	0.904	172.25	4.144	71.29	0.031	-4.06	0.670	170.01	0.40	21.26
1.00	0.903	169.17	3.729	68.22	0.031	-5.54	0.670	167.69	0.45	20.80
1.10	0.903	166.26	3.393	65.17	0.031	-7.10	0.671	165.50	0.49	20.39
1.20	0.903	163.57	3.115	62.32	0.031	-8.31	0.672	163.46	0.54	20.02
1.30	0.902	160.94	2.878	59.48	0.031	-9.72	0.672	161.46	0.59	19.68
1.40	0.902	158.40	2.675	56.63	0.031	-11.05	0.673	159.54	0.63	19.36
1.50	0.901	155.94	2.497	53.91	0.031	-12.24	0.674	157.65	0.68	19.06
1.60	0.900	153.50	2.344	51.18	0.031	-13.54	0.675	155.81	0.73	18.79
1.70	0.900	151.13	2.207	48.51	0.031	-14.55	0.675	154.03	0.77	18.52
1.80	0.899	148.74	2.087	45.82	0.031	-16.11	0.676	152.22	0.82	18.28
1.90	0.898	146.42	1.978	43.18	0.031	-17.19	0.677	150.61	0.87	18.05
2.00	0.898	144.10	1.882	40.54	0.031	-18.30	0.679	148.90	0.92	17.62
2.10	0.897	141.78	1.794	37.96	0.031	-19.09	0.680	147.27	0.97	17.62
2.20	0.896	139.45	1.714	35.31	0.031	-20.36	0.680	145.62	1.02	16.50
2.30	0.896	137.20	1.641	32.77	0.031	-21.58	0.682	144.10	1.06	15.73
2.40	0.895	134.95	1.575	30.22	0.031	-22.87	0.684	142.52	1.11	15.06
2.50	0.895	132.69	1.514	27.72	0.031	-24.28	0.686	141.08	1.14	14.60
2.60	0.894	130.42	1.458	25.19	0.031	-25.45	0.687	139.60	1.92	14.07
2.70	0.894	128.13	1.406	22.65	0.031	-26.78	0.689	138.08	1.23	13.69
2.80	0.893	125.84	1.360	20.17	0.031	-27.62	0.690	136.71	1.28	13.25
2.90	0.892	123.53	1.315	17.71	0.031	-29.24	0.693	135.40	1.32	12.90
3.00	0.891	121.12	1.273	15.17	0.031	-30.07	0.695	133.97	1.37	12.51
3.10	0.890	118.74	1.237	12.88	0.030	-31.40	0.699	132.83	1.45	12.17
3.20	0.889	116.40	1.199	10.24	0.031	-31.97	0.699	131.33	1.47	11.83
3.30	0.889	113.93	1.167	7.72	0.031	-33.46	0.703	130.05	1.49	11.63
3.40	0.888	111.57	1.134	5.26	0.031	-34.38	0.704	128.87	1.54	11.30
3.50	0.887	109.17	1.105	2.79	0.031	-35.71	0.708	127.72	1.57	11.07
3.6	0.886	106.64	1.078	0.35	0.031	-37.09	0.711	126.68	1.61	10.84
3.7	0.886	1.04.11	1.052	-2.06	0.031	-38.46	0.715	125.68	1.62	10.68
3.8	0.885	101.52	1.027	-4.48	0.032	-39.84	0.719	124.84	1.60	10.51
3.9	0.885	98.85	1.005	-6.81	0.032	-40.94	0.725	124.23	1.61	10.40
4.0	0.882	95.89	0.985	-9.16	0.032	-42.41	0.734	123.96	1.63	10.25

Note:

1. Gain calculation:

$$MAG = \frac{|S_{21}|}{|S_{12}|} \left(K \pm \sqrt{K^2 - 1} \right). \text{ When } K \leq 1, \text{ MAG is undefined and MSG values are used. } MSG = \frac{|S_{21}|}{|S_{12}|}, K = \frac{1 + |\Delta|^2 - |S_{11}|^2 - |S_{22}|^2}{2 |S_{12}| |S_{21}|}, \Delta = S_{11} S_{22} - S_{21} S_{12}$$

MAG = Maximum Available Gain
MSG = Maximum Stable Gain

TYPICAL SCATTERING PARAMETERS (T_A = 25°C)

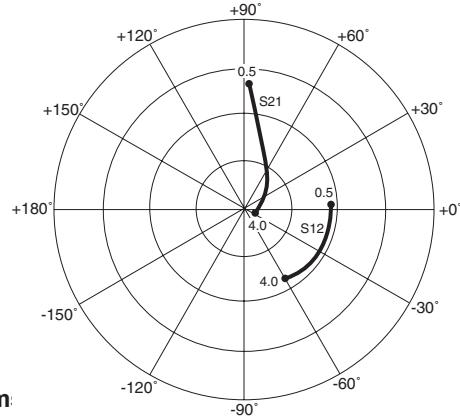
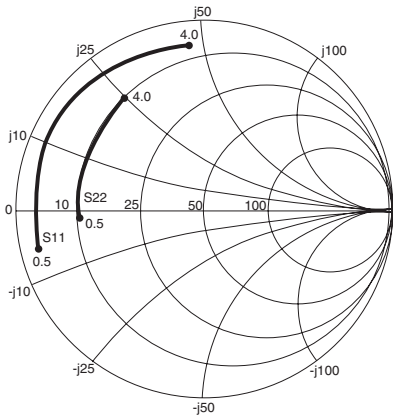

Coordinates in Ohm:
Frequency in GHz
V_D = 3.5 V, I_D = 50 mA

V_D = 3.5 V, I_D = 50 mA

FREQUENCY GHz	S ₁₁		S ₂₁		S ₁₂		S ₂₂		K	MAG ¹ (dB)
	MAG	ANG	MAG	ANG	MAG	ANG	MAG	ANG		
0.50	0.89	-168.01	6.49	86.49	0.04	2.44	0.63	-173.92	0.17	21.59
0.60	0.89	-173.64	5.43	82.00	0.04	-0.91	0.63	-177.95	0.21	20.82
0.70	0.89	-178.28	4.68	78.02	0.04	-3.46	0.63	178.68	0.25	20.17
0.80	0.89	177.73	4.10	74.39	0.04	-5.97	0.63	175.74	0.29	19.59
0.90	0.89	174.20	3.65	70.90	0.04	-8.08	0.63	173.09	0.32	19.09
1.00	0.89	170.95	3.29	67.60	0.04	-10.18	0.63	170.63	0.36	18.64
1.10	0.89	167.90	2.99	64.34	0.04	-12.21	0.64	168.31	0.40	18.23
1.20	0.89	165.11	2.75	61.32	0.04	-14.08	0.64	166.20	0.43	17.86
1.30	0.89	162.38	2.54	58.30	0.04	-15.97	0.64	164.15	0.47	17.51
1.40	0.89	159.77	2.36	55.29	0.04	-17.77	0.64	162.17	0.50	17.19
1.50	0.89	157.25	2.20	52.40	0.04	-19.54	0.64	160.27	0.56	16.99
1.60	0.88	154.75	2.07	49.51	0.04	-21.34	0.64	158.40	0.60	16.72
1.70	0.88	152.33	1.95	46.67	0.04	-22.87	0.64	156.62	0.64	16.46
1.80	0.88	149.91	1.84	43.82	0.04	-24.84	0.64	154.81	0.67	16.21
1.90	0.88	147.55	1.74	41.04	0.04	-26.40	0.65	153.20	0.72	15.98
2.00	0.88	145.21	1.66	38.26	0.04	-28.02	0.65	151.49	0.77	15.86
2.10	0.88	142.87	1.58	35.55	0.04	-29.38	0.65	149.87	0.81	15.65
2.20	0.88	140.51	1.51	32.76	0.04	-31.08	0.65	148.24	0.86	15.45
2.30	0.88	138.25	1.44	30.08	0.04	-32.73	0.65	146.74	0.89	15.26
2.40	0.88	135.98	1.39	27.39	0.04	-34.35	0.66	145.17	0.93	15.08
2.50	0.88	133.71	1.33	24.76	0.04	-36.08	0.66	143.74	0.96	14.91
2.60	0.88	131.45	1.28	22.10	0.04	-37.68	0.66	142.27	1.03	13.82
2.70	0.88	129.14	1.23	19.43	0.04	-39.43	0.66	140.78	1.05	13.24
2.80	0.88	126.84	1.19	16.80	0.04	-40.80	0.66	139.41	1.10	12.64
2.90	0.88	124.54	1.15	14.23	0.04	-42.57	0.67	138.12	1.13	12.17
3.00	0.88	122.13	1.12	11.57	0.04	-44.05	0.67	136.69	1.20	11.61
3.10	0.88	119.76	1.08	9.15	0.04	-45.84	0.68	135.56	1.22	11.38
3.20	0.87	117.42	1.05	6.40	0.04	-46.80	0.68	134.07	1.27	10.94
3.30	0.87	114.95	1.02	3.77	0.04	-48.59	0.68	132.79	1.29	10.71
3.40	0.87	112.59	0.99	1.18	0.04	-49.84	0.68	131.61	1.34	10.34
3.50	0.87	110.20	0.97	-1.40	0.04	-51.37	0.69	130.47	1.36	10.14
3.60	0.87	107.68	0.94	-3.98	0.04	-53.04	0.69	129.41	1.40	9.86
3.70	0.87	105.16	0.92	-6.50	0.04	-54.52	0.70	128.40	1.41	9.67
3.80	0.87	102.57	0.90	-9.02	0.04	-56.08	0.70	127.55	1.44	9.47
3.90	0.87	99.92	0.88	-11.46	0.04	-57.48	0.71	126.90	1.44	9.34
4.00	0.87	97.00	0.86	-13.94	0.04	-59.08	0.72	126.57	1.45	9.20

Note:

1. Gain calculation:

$$MAG = \frac{|S_{21}|}{|S_{12}|} \left(K \pm \sqrt{K^2 - 1} \right). \text{ When } K \leq 1, \text{ MAG is undefined and MSG values are used. } MSG = \frac{|S_{21}|}{|S_{12}|}, K = \frac{1 + |\Delta|^2 - |S_{11}|^2 - |S_{22}|^2}{2 |S_{12}| |S_{21}|}, \Delta = S_{11} S_{22} - S_{21} S_{12}$$

MAG = Maximum Available Gain
MSG = Maximum Stable Gain

APPLICATION CIRCUIT (2.50 - 2.70 GHz)

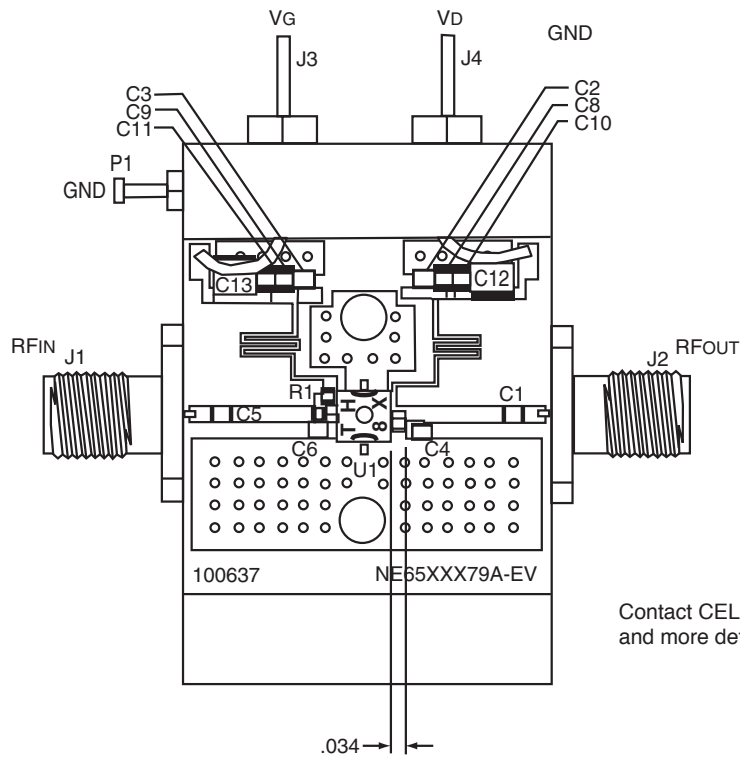

Contact CEL Engineering for artwork and more detailed information.

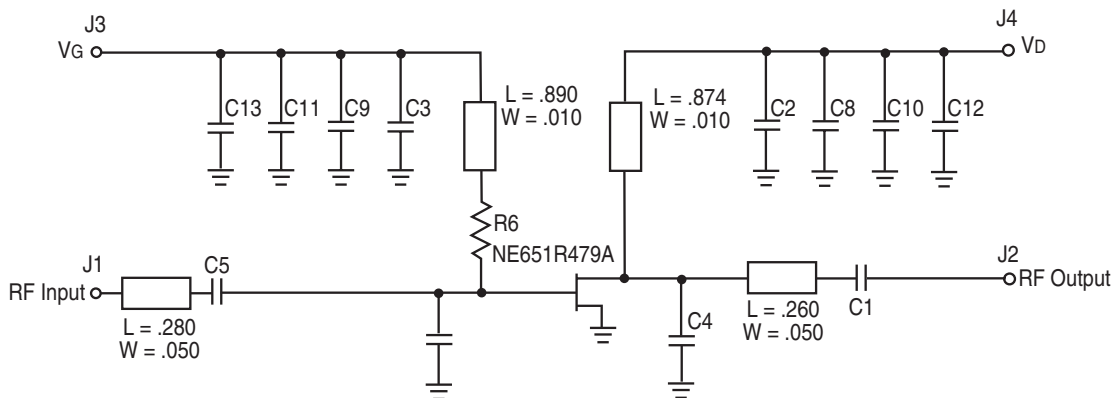

1	TF-100637		TEST CIRCUIT BLK	15
4			2-56 X 3/16 PHILLIPS PAN HEAD	14
2	MA101J	C2, C3	CASE 1 100 pF CAP MURATA	13
1	MCR03J201	R1	0603 200 OHM RESISTOR ROHM	12
2	100A5R1CP150X	C1, C5	CASE A 5.1 pF CAP ATC	11
1	100A002CP150X	C4	CASE A 2.0 pF CAP ATC	10
1	100A1R5JP150X	C6	CASE A 1.5 pF CAP ATC	9
2	491A105K025AS-X	C12, C13	CASE A 1uF KEMET	8
2	GRM40X7R104K025BL	C10, C11	0805 1uF CAP MURATA	7
2	GRM40C0G102J050BD	C8, C9	0805 1000 pF CAP MURATA	6
1	NE6510179A	U1	IC NEC	5
1	703401	P1	GROUND LUG CONCORD	4
1	1250-003	J3, J4	FEEDTHRU MURATA	3
1	2052-5636-02	J1, J2	FLANGE MOUNT JACK RECEPTACLE	2
2	FD-100637	PCB	NE6500379A-EVAL FABRICATION DRAWING	1

TYPICAL APPLICATION CIRCUIT PERFORMANCE at $V_{DS} = 3.5\text{ V}$ and $V_{DS} = 5\text{ V}$

GAIN AND SATURATED POWER vs. FREQUENCY

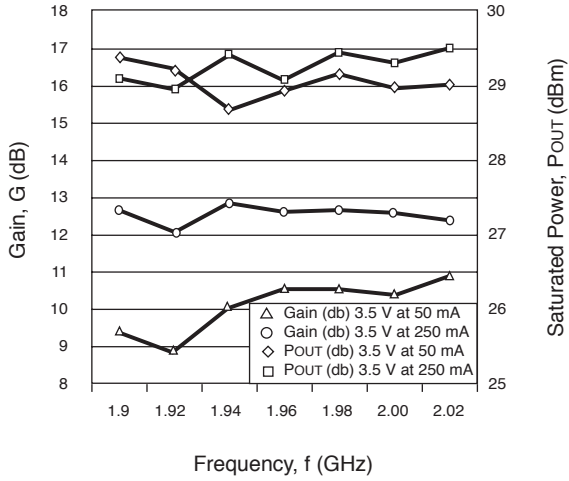

GAIN AND SATURATED POWER vs. FREQUENCY

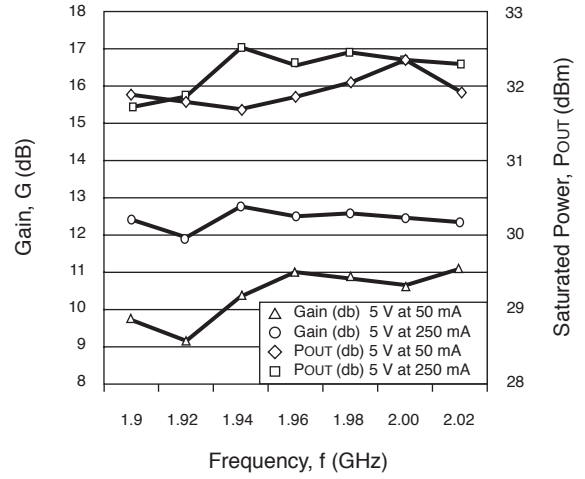

POWER ADDED EFFICIENCY & GAIN vs. OUTPUT POWER

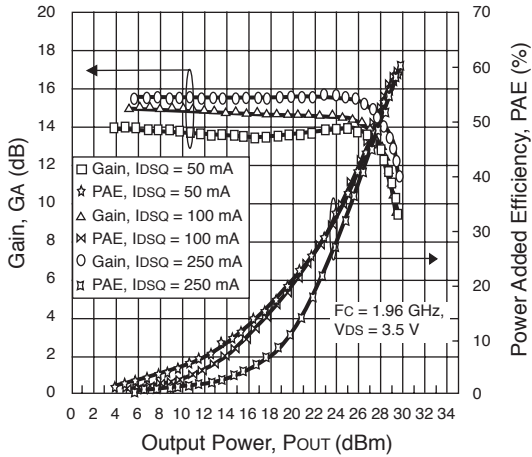

POWER ADDED EFFICIENCY & GAIN vs. OUTPUT POWER

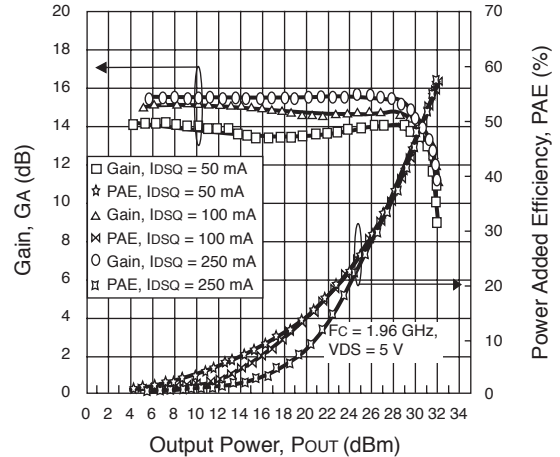

THIRD ORDER INTERMODULATION vs. TOTAL OUTPUT POWER

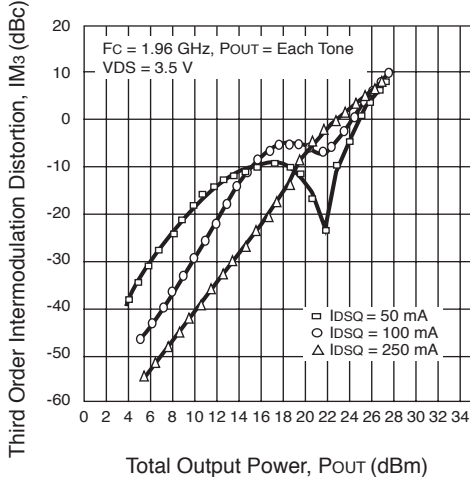

THIRD ORDER INTERMODULATION vs. TOTAL OUTPUT POWER

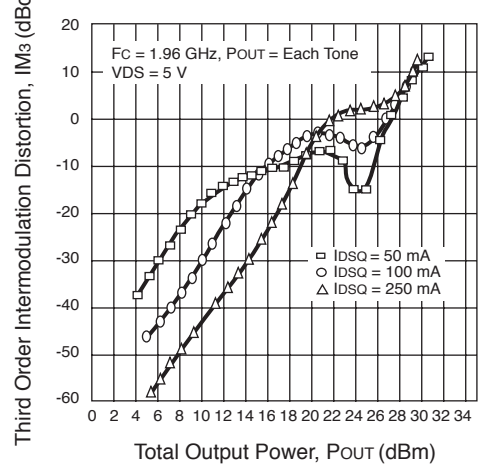

TYPICAL APPLICATION CIRCUIT PERFORMANCE at $V_{DS} = 5\text{ V}$, $f = 2.66\text{ GHz}$

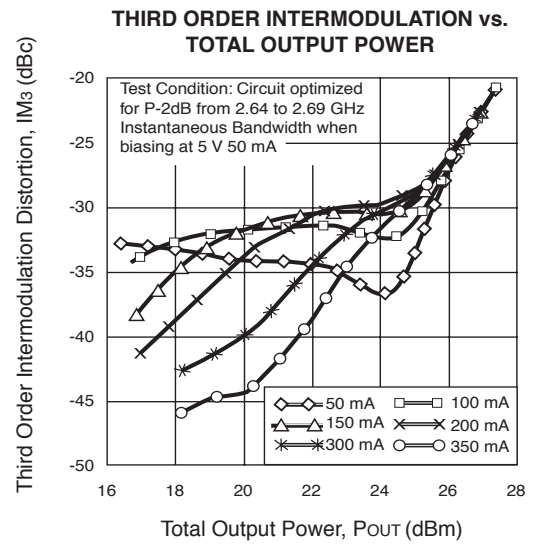
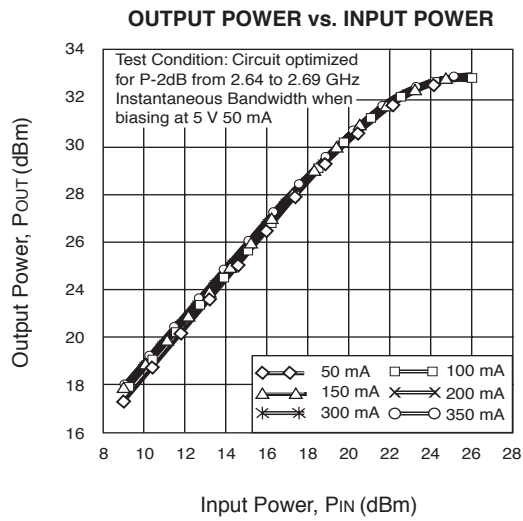

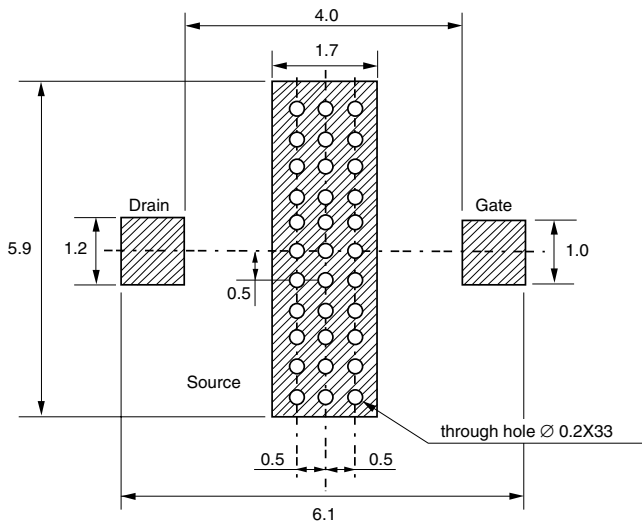
RECOMMENDED P.C.B. LAYOUT (Units in mm)**RECOMMENDED SOLDERING CONDITIONS¹**

This product should be soldered under the following recommended conditions. For soldering methods and conditions other than those recommended below, contact your CEL sales representative.

SOLDERING METHOD	SOLDERING CONDITIONS	RECOMMENDED CONDITION SYMBOL
Infrared Reflow	Package peak temperature: 235 °C or below Time: 30 seconds or less (at 210 °C) Count: 2, Exposure limit: none	IR35-00-2
Partial Heating	PIN temperature: 260 °C Time: 5 seconds or less (per pin row) Exposure limit: none	-

Note:

1. Caution: Do not use different soldering methods together (except for partial heating).

Subject: Compliance with EU Directives

CEL certifies, to its knowledge, that semiconductor and laser products detailed below are compliant with the requirements of European Union (EU) Directive 2002/95/EC Restriction on Use of Hazardous Substances in electrical and electronic equipment (RoHS) and the requirements of EU Directive 2003/11/EC Restriction on Penta and Octa BDE.

CEL Pb-free products have the same base part number with a suffix added. The suffix –A indicates that the device is Pb-free. The –AZ suffix is used to designate devices containing Pb which are exempted from the requirement of RoHS directive (*). In all cases the devices have Pb-free terminals. All devices with these suffixes meet the requirements of the RoHS directive.

This status is based on CEL’s understanding of the EU Directives and knowledge of the materials that go into its products as of the date of disclosure of this information.

Restricted Substance per RoHS	Concentration Limit per RoHS (values are not yet fixed)	Concentration contained in CEL devices	
		-A	-AZ
Lead (Pb)	< 1000 PPM	Not Detected	(*)
Mercury	< 1000 PPM	Not Detected	
Cadmium	< 100 PPM	Not Detected	
Hexavalent Chromium	< 1000 PPM	Not Detected	
PBB	< 1000 PPM	Not Detected	
PBDE	< 1000 PPM	Not Detected	

If you should have any additional questions regarding our devices and compliance to environmental standards, please do not hesitate to contact your local representative.

Important Information and Disclaimer: Information provided by CEL on its website or in other communications concerning the substance content of its products represents knowledge and belief as of the date that it is provided. CEL bases its knowledge and belief on information provided by third parties and makes no representation or warranty as to the accuracy of such information. Efforts are underway to better integrate information from third parties. CEL has taken and continues to take reasonable steps to provide representative and accurate information but may not have conducted destructive testing or chemical analysis on incoming materials and chemicals. CEL and CEL suppliers consider certain information to be proprietary, and thus CAS numbers and other limited information may not be available for release.

In no event shall CEL’s liability arising out of such information exceed the total purchase price of the CEL part(s) at issue sold by CEL to customer on an annual basis.

See CEL Terms and Conditions for additional clarification of warranties and liability.