

REV.	ECN NO.	DATE	SIGN	DESCRIPTION

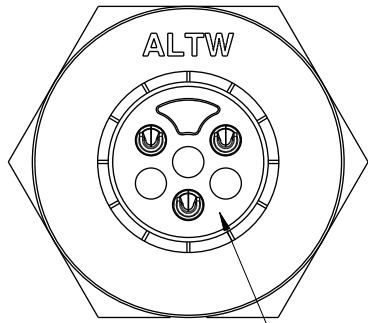

Whit Liquid Glue

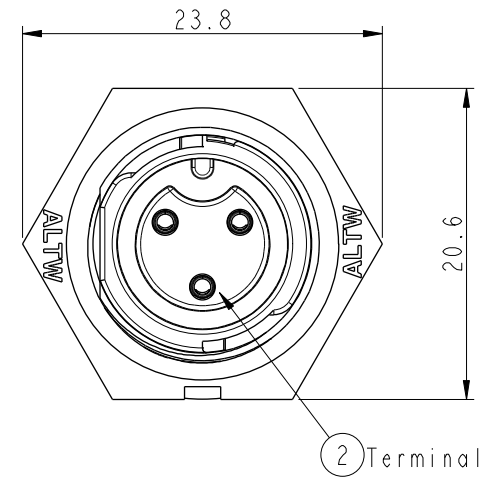
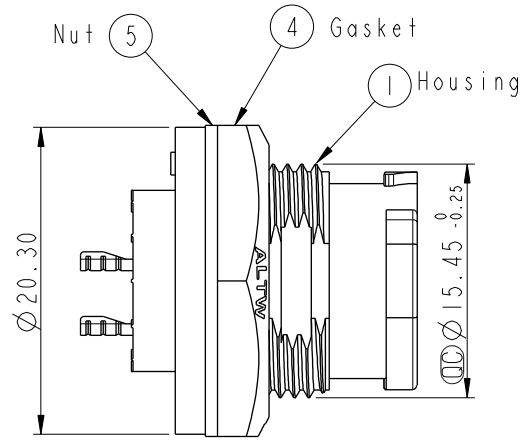

ALTW
CONFIDENTIAL
2014-10-20
R&D DEPT.

ALTW
DCC. DEPT.
CONFIDENTIAL
2014.11.26
ISSUED

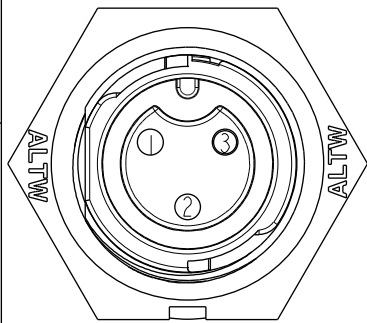

Pin Assignments
Front View

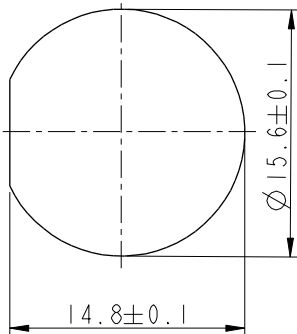

Recommended Panel Cut-out

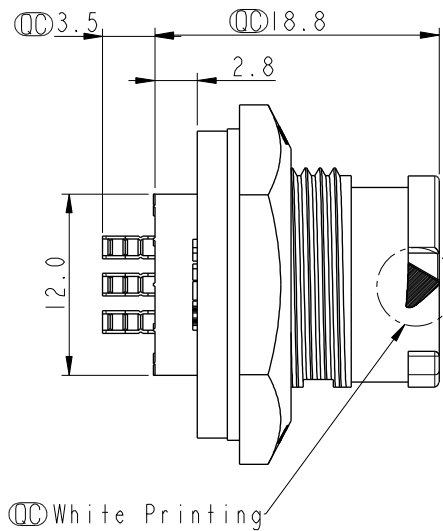

Note:

- * \varnothing Important Dimension To Check.
- * Waterproof Rate: IP68
- * Working Voltage Rating: AC 300 V
- * Working Current Rating: 5A
- * Flame Class: UL94V-0 (UV Resistance)
- * Housing: Nylon+GF, Black
- * Female Pin: Copper Alloy, Gold Plated
- * Nut: Nylon+GF, Black
- * Gasket: Silicone, Gray
- * Use Without Waterproof Cap
Panel Thickness Max: 4.0mm
- * Use With Waterproof Cap
Panel Thickness Max: 3.0mm

UNIT:mm

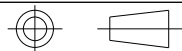

TITLE
X Lok B-Size
Receptacle M Conn F 3 Pin

Amphenol LTW
安費諾亮泰企業股份有限公司

ITEM NO. BD-03PMFS-QC8001	DRAWN BY Micky	DATE 2014-10-20
DWG NO. BD-03PMFS-QC8001	CHECKED BY Spring	DATE 2014-10-20
CUSTOMER ALTW	APPROVED BY Kevin	DATE 2014-10-20

SCALE 2:1	SIZE A4	SHEET 1	OF 1
REV. A	WC-REV. A.1	\varnothing : Inspection item	

THIS DOCUMENT IS SUBJECT TO CHANGE WITHOUT NOTICE. IT IS CONFIDENTIAL AND A PROPERTY OF Amphenol LTW. DISCLOSURE TO THIRD PARTY HAS TO BE AUTHORIZED BY Amphenol LTW.