

Description

- Industry standard SMD crystal
Resistance welded, hermetically sealed in an inert atmosphere, glass to metal seals on leads
Lead wires are mounted onto a plastic former to create a gull wing mount
- Model HC49/4HSMX
- Model Issue number 17

Frequency Parameters

- Frequency 4.0MHz
- Frequency Tolerance $\pm 30.00\text{ppm}$
- Tolerance Condition @ 25°C $\pm 2^\circ\text{C}$
- Frequency Stability $\pm 50.00\text{ppm}$
- Operating Temperature Range -20.00 to 70.00°C
- Overtone Order Fundamental
- Ageing $\pm 5\text{ppm typ per year @ } 25^\circ\text{C}$

Electrical Parameters

- Load Capacitance (CL) 20.00pF
- Shunt Capacitance (C0) 7pF max
- Drive Level 500µW max
- ESR 130.00Ω max

Environmental Parameters

- Shock: 981m/s², 6ms, 3 times in each of 3 mutually perpendicular planes
- Vibration: 10Hz-60Hz, 0.75mm amplitude, 60Hz-500Hz, 98.1m/s², 30mins in 3 mutually perpendicular planes
- Storage Temperature Range: -55 to 125°C

Compliance

- RoHS Status (2011/65/EU) Compliant
- REACH Status Compliant
- MSL Rating (JDEC-STD-033): Not Applicable

Packaging Details

- Pack Style: Reel Tape & reel in accordance with EIA-481-D
Pack Size: 1,000
- *Alternative packing option available*

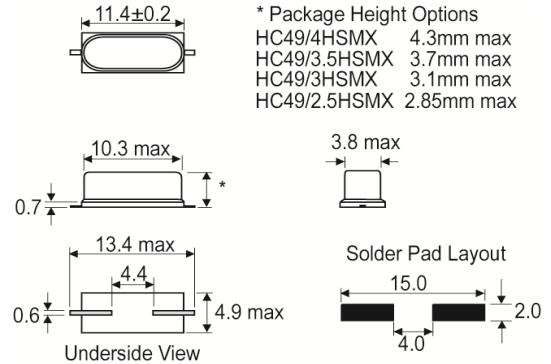
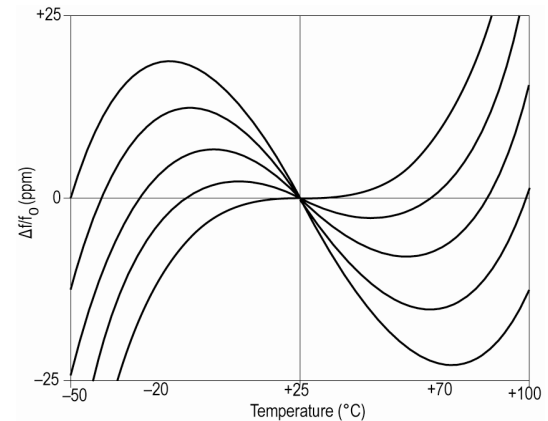
Outline (mm)

Typical Frequency vs Temperature Curves

Sales Office Contact Details:

UK: +44 (0)1460 270200
 Germany: 0800 1808 443

France: 0800 901 383
 USA: +1.760.318.2824

Email: info@iqdfrequencyproducts.com
 Web: www.iqdfrequencyproducts.com