

Infrared Receiver Control Receiver Module EAIRMIA1

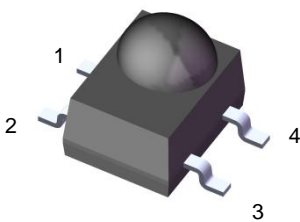

Pin Configuration

1. GND
2. GND
3. OUT
4. Vcc

Block Diagram

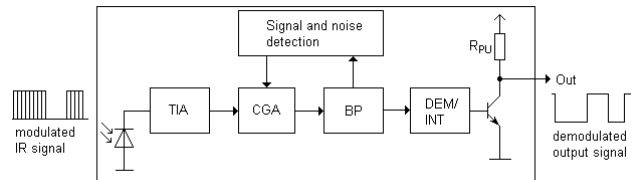

Features

- High protection ability against EMI
- Available for various carrier frequencies
- Circular lens for improve reception characteristic
- Min burst length: 8 cycles
- Min gap length: 12 cycles
- Low operating voltage and low power consumption
- High immunity against ambient light
- High immunity against TFT and PDP backlight
- Long reception range
- High sensitivity
- Pb free and RoHS compliant
- Compliance with EU REACH.
- Compliance Halogen Free .(Br <900 ppm ,Cl <900 ppm , Br+Cl < 1500 ppm).

Description

- The device is miniature SMD type infrared receiver that has been developed and designed by utilizing the latest IC technology.
- The PIN diode and preamplifier are assembled onto a lead frame and molded into an epoxy package which operated an IR filter. The demodulated output signal can directly be decoded by a microprocessor.

Applications

- Light detecting portion of remote control
- AV instruments such as Audio, TV, VCR, CD, MD, etc
- Home appliances such as Air-conditioner, Fan, etc
- Other devices using IR remote control
- CATV set top boxes
- Multi-media Equipment

Application Circuit

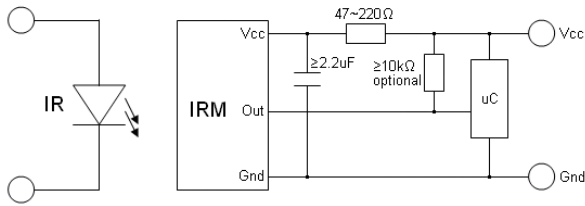

Parts Table

Model No.	Carrier Frequency
EAIRMIA1	38 kHz

Absolute Maximum Ratings (Ta=25°C)

Parameter	Symbol	Rating	Unit
Supply Voltage	Vcc	6	V
Operating Temperature	Topr	-20 ~ +85	°C
Storage Temperature	Tstg	-40 ~ +85	°C
Soldering Temperature ^{*1}	Tsol	260	°C

^{*1} 4mm from mold body for less than 10 seconds

Electro-Optical Characteristics (Ta=25°C)

Parameter	Symbol	Min.	Typ.	Max.	Unit	Condition
Current consumption	I _{CC}	-	0.4	0.6	mA	No input signal
Supply voltage	V _{CC}	2.7	-	5.5	V	
Peak wavelength	λ _p	---	940	---	nm	
Reception range	L ₀	8	---	---	m	See chapter ,Test method'
	L ₄₅	5	---	---		
High level pulse width	T _H	450	-	750	μs	Test signal according to figure 1
Low level pulse width	T _L	450	-	750	μs	
High level output voltage	V _{OH}	V _{CC} -0.4	---	---	V	
Low level output voltage	V _{OL}	---	0.2	0.5	V	I _{SINK} ≤ 2mA
Internal pull up resistor	R _{PU}	34	40	46	kΩ	

Test method

The specified electro-optical characteristics are valid under the following conditions.

1. Measurement environment

A place without extreme light reflections.

2. External light

The environment contains an ordinary, white fluorescent lamp without high frequency modulation. The color temperature is 2856K and the illumination at the IR receiver is less than 10 Lux ($E_v \leq 10\text{Lux}$).

3. Standard transmitter

The test transmitter is calibrated by using the circuit shown in figure 2. The radiation intensity of the transmitter is adjusted until $V_o=400\text{mVp-p}$. Both, the test transmitter and the photo diode, have a peak wavelength of 940nm. The photo diode for calibration is PD438B ($\lambda_p=940\text{nm}$, $V_r=5\text{V}$).

4. The measurement system is shown in Fig.-3

Fig.-1 Transmitter Wave Form

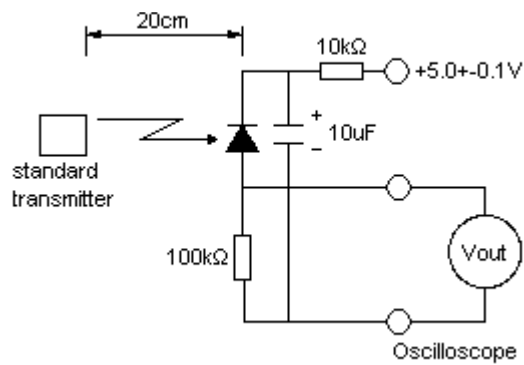
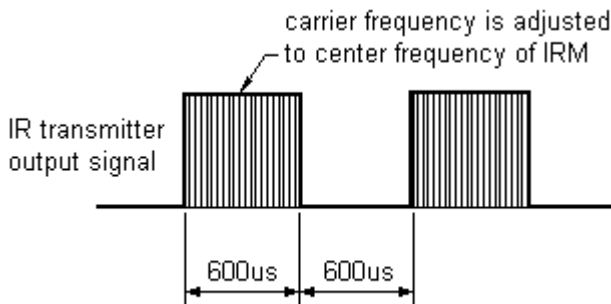

D.U.T output Pulse

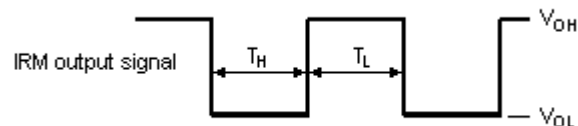
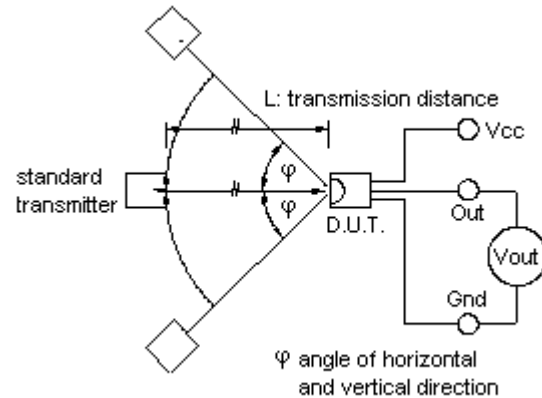

Fig.-3 Measuring System



Typical Electro-Optical Characteristics Curves

Fig.4 Relative Responsibility vs. Wavelength

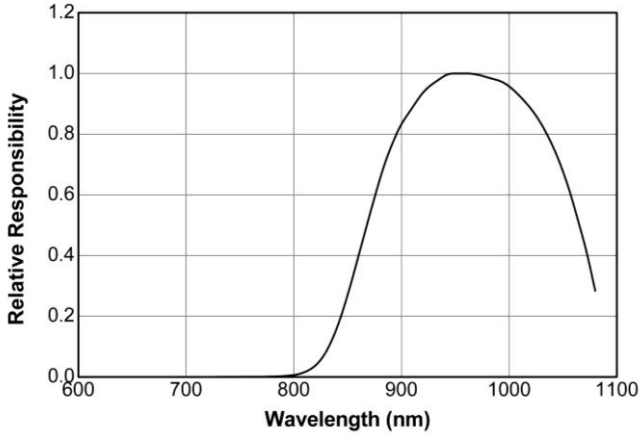

Fig.-5 Relative Sensitivity vs. Angle

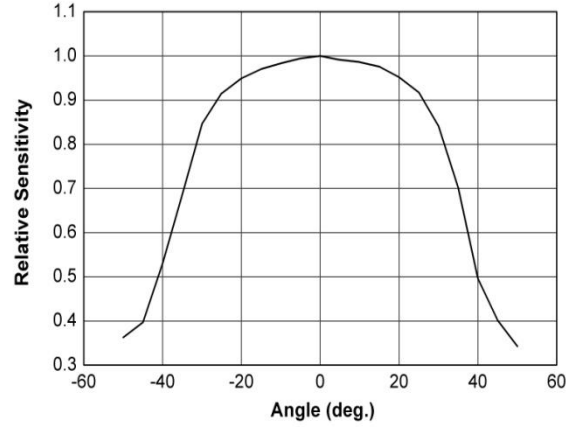

Fig.6 Variation Output Pulse Width vs. Distance

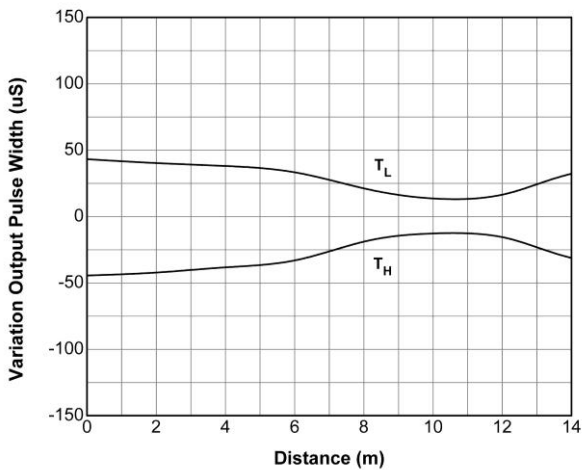

Fig.7 Relative Sensitivity vs. Supply Voltage

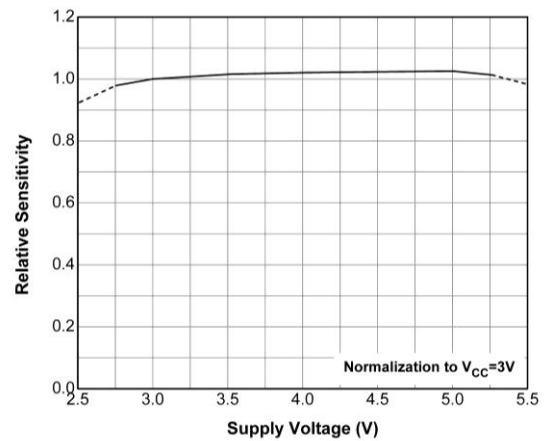
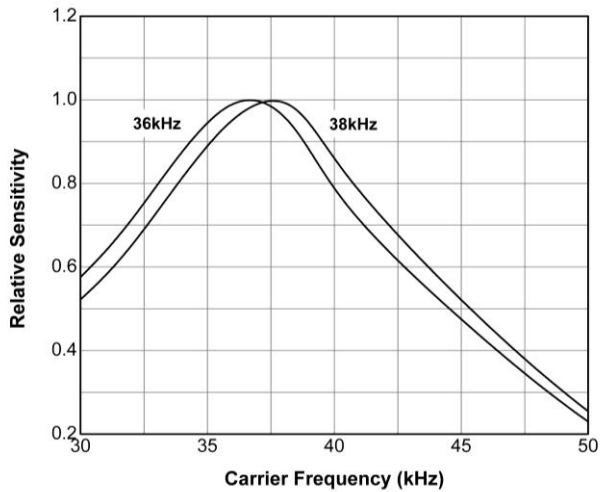
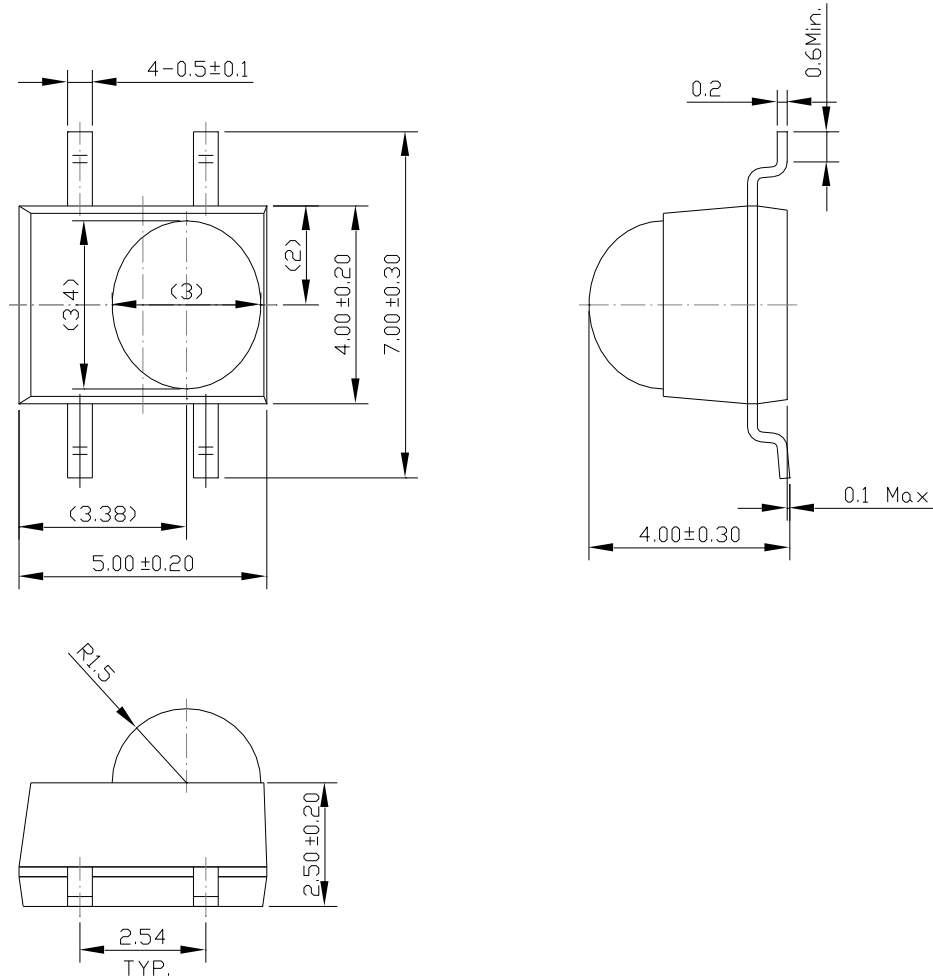

Fig.8 Relative Sensitivity vs. Carrier Frequency



Package Dimension
 (Dimensions in mm)



Recommended pad layout for surface mount leadform

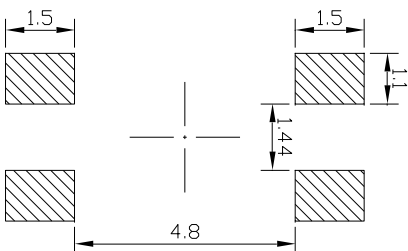

Code information

Protocol	Suitable	Protocol	Suitable
JVC	Yes	RCA	No
Matsushita	Yes	Sharp	Yes
Mitsubishi	No	Sony 12 Bit	Yes
NEC	Yes	Sony 15 Bit	No
RC5	Yes	Sony 20Bit	No
RC6	Yes	Toshiba	Yes
RCMM	No	Zenith	Yes
RCS-80	No	Continuous Code	No



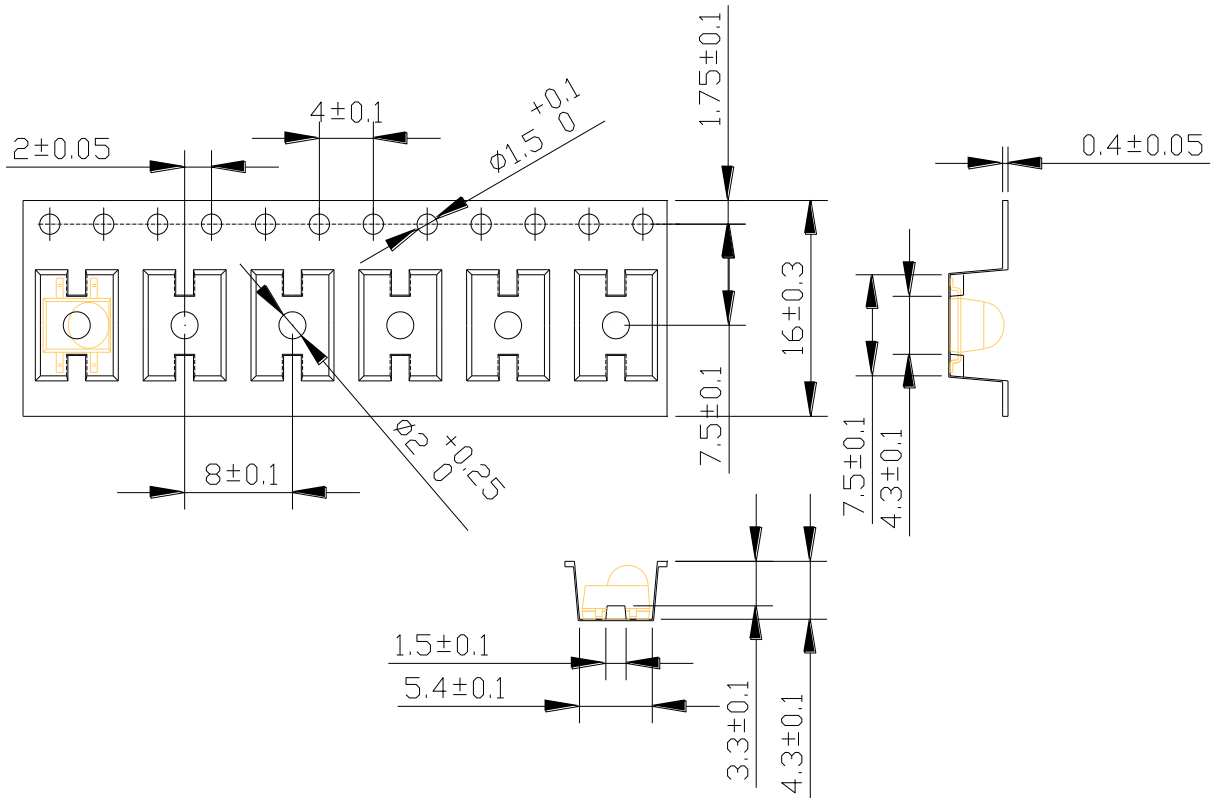

Tape & Reel Packing Specifications (Dimensions in mm)



Packing Quantity

1000 pcs / Reel
5 Reels / Carton

Label format

	EVERLIGHT
CPN:	
P/N: 30XXXXXXXX	
	RoHS
IRM-XXXX/TRX	
QTY: 2000	CAT:
	HUE:
LOT NO:	REF:
	
MADE IN CHINA	

	Caution This bag contains MOISTURE-SENSITIVE DEVICES	LEVEL <input type="text"/>
<p>1. Calculated shelf life in sealed bag: 12 months at <40°C and <90% relative humidity (RH)</p> <p>2. Peak package body temperature: _____ °C <small>If blank, see adjacent bar code label</small></p> <p>3. After bag is opened, devices that will be subjected to reflow solder or other high temperature process must</p> <p>a) Mounted within: _____ hours of factory conditions <small>If blank, see adjacent bar code label</small></p> <p style="padding-left: 20px;"><30°C/60% RH, OR</p> <p>b) Stored at <10% RH</p> <p>4. Devices require bake, before mounting, if:</p> <p>a) Humidity Indicator Card is >10% when read at 23 ± 5°C</p> <p>b) 3a or 3b not met</p> <p>5. If baking is required, devices may be baked for 48 hours at 125 ± 5°C</p> <p><small>Note: If device containers cannot be subjected to high temperature or shorter bake times are desired, reference IPC/JEDEC J-STD-033 for bake procedure</small></p> <p>Bag Seal Date: _____ <small>If blank, see adjacent bar code label</small></p> <p><small>Note: Level and body temperature defined by IPC/JEDEC J-STD-020</small></p>		

Moisture Classification-storage and used condition label

Recommended method of storage

The following are general recommendations for moisture sensitive level (MSL) 4 storage and use:

1. Shelf life in sealed bag from the bag seal date: 12 months at < 40 °C and < 90% relative humidity (RH)
2. After bag is opened, devices that will be subjected to reflow solder or other high temperature process must mounted within 72 hours of factory conditions < 30 °C/60%RH.
3. If the moisture absorbent material (silica gel) has faded away or the IRM has exceeded the storage time. Baking treatment is required, refer to IPC/JEDEC J-STD-033 for bake procedure or recommend the conditions: 60±5°C for 96 hours.

ESD Precaution

Proper storage and handing procedures should be followed to prevent ESD damage to the devices especially when they are removed from the Anti-static bag. Electro-Static Sensitive Devices warning labels are on the packing.

Solder Reflow Temperature Profile

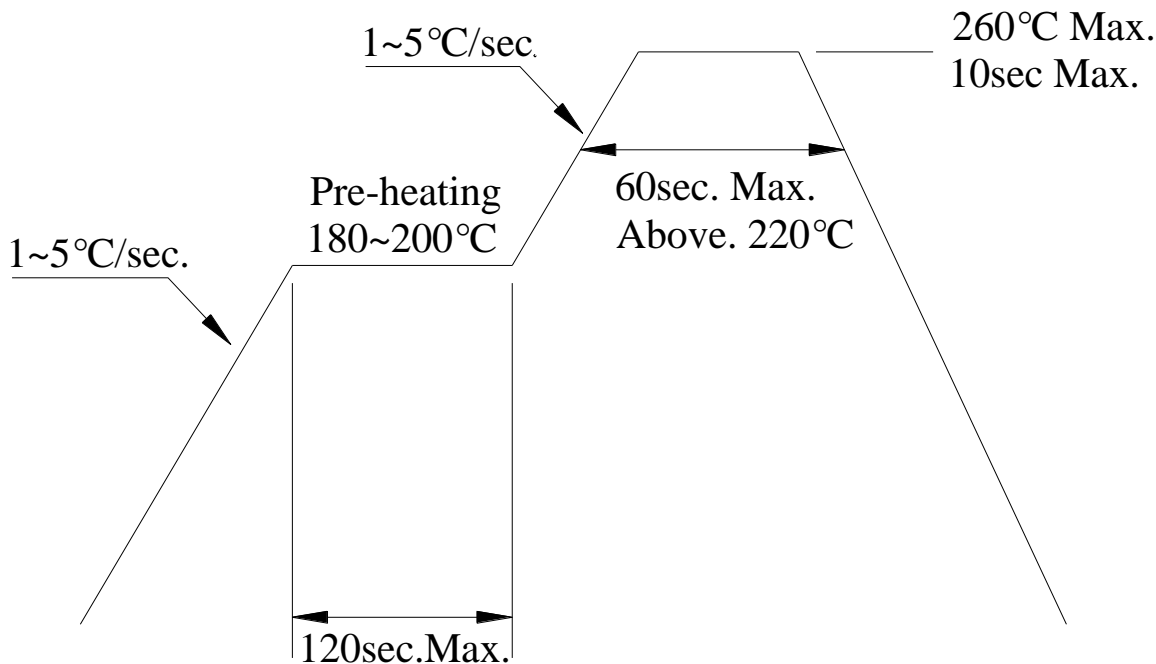

Note:

1. Reflow soldering should not be done more than two times.
2. When soldering, do not put stress on the IRM device during heating.
3. After soldering, do not warp the circuit board.

Application Restrictions

1. Above specification may be changed without notice. Everlight Americas will reserve authority on material change for above specification.
2. When using this product, please observe the absolute maximum ratings and the instructions for use outlined in these specification sheets. Everlight Americas assumes no responsibility for any damage resulting from use of the product which does not comply with the absolute maximum ratings and the instructions included in these specification sheets.
3. These specification sheets include materials protected under copyright of Everlight Americas. Reproduction in any form is prohibited without the specific consent of Everlight Americas.