

Features:

- Quick and Simple to Install
- Up to 500m range outdoor
- Up to 50-100m range in buildings*
- Reliable high end radio link
- High Quality UK manufacture
- Weatherproof IP65 Enclosures
- Easy Connection with Screw Terminals
- Supplied pre-configured ready to operate
- Operates from 230V or 110V



Applications:

- Switched live cable replacement
- Thermostat cable replacement

Description

The RF Solutions **MAINSLINK** is designed to offer a solution to switched live cabling. When a cable run is awkward or expensive to achieve, the **MAINSLINK** can be used, saving time and money.

Ordering Information

Part Number	Description
MAINSLINK	MAINSLINK System (Supplied complete with Tx/Rx)
MAINSLINK-RX	MAINSLINK Receiver unit

Cable Connections

MAINSLINK is very easy to connect, simply wire as follows:

MAINSLINK-TX - Transmitter:

1. Run a switched Live from your external device or switch to the MAINSLINK-TX Transmitter and connect into the screw terminal marked: L (Live)
2. Run a Neutral to the MAINSLINK-TX and connect to the terminal marked N (Neutral).

AS SHOWN IN FIG 1.1

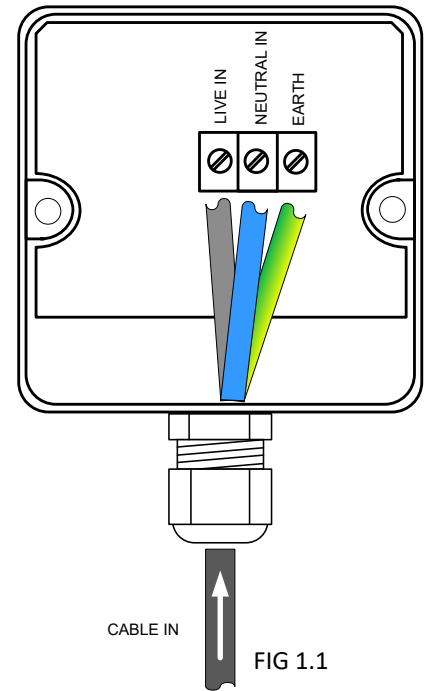

FIG 1.1

Transmitter - MAINSLINK-TX

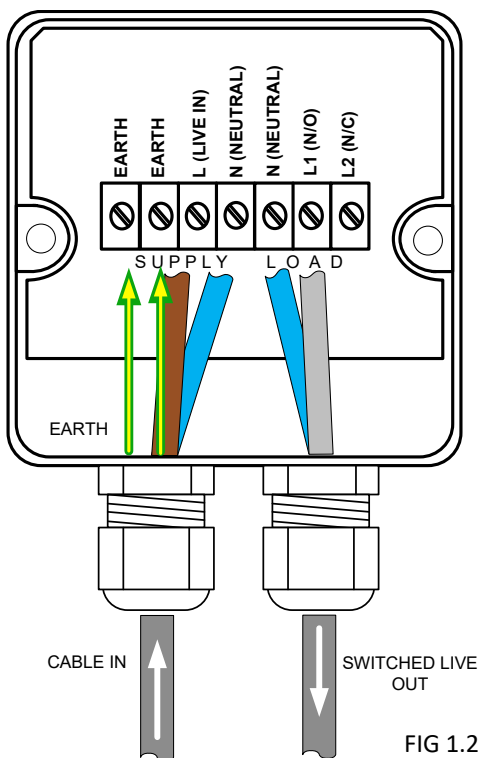

FIG 1.2

Receiver - MAINSLINK-RX

MAINSLINK-RX - Receiver:

1. Connect the Supply: LIVE, NEUTRAL and EARTH. Connect the Live to the screw terminal marked: LIVE then connect the NEUTRAL and EARTH respectively.
2. Connect the LOAD to the receiver and wire in as required.
3. In most applications the LOAD would be wired as shown in FIG 1.2

Important Notes:

- All mains powered units must be earthed
- Hardwired units must be connected via an isolating switch
- See Safety information on page 5 before installing

MAINSLINK System Operation

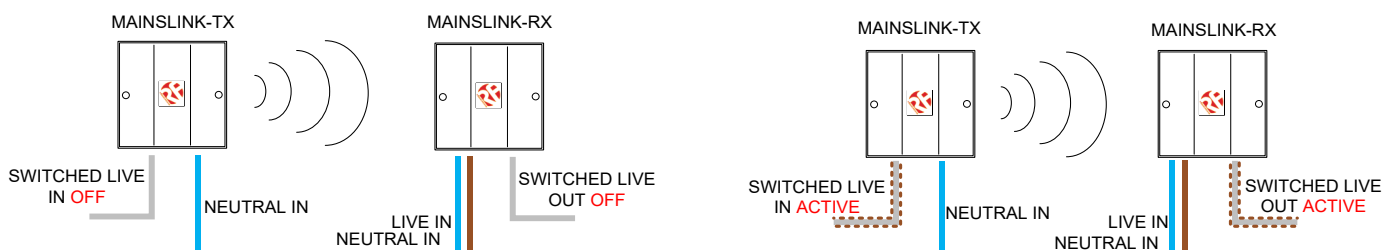

Dimensions and Wall mounting information:

MAINSLINK is a professional use product and should only be installed by a competent person.

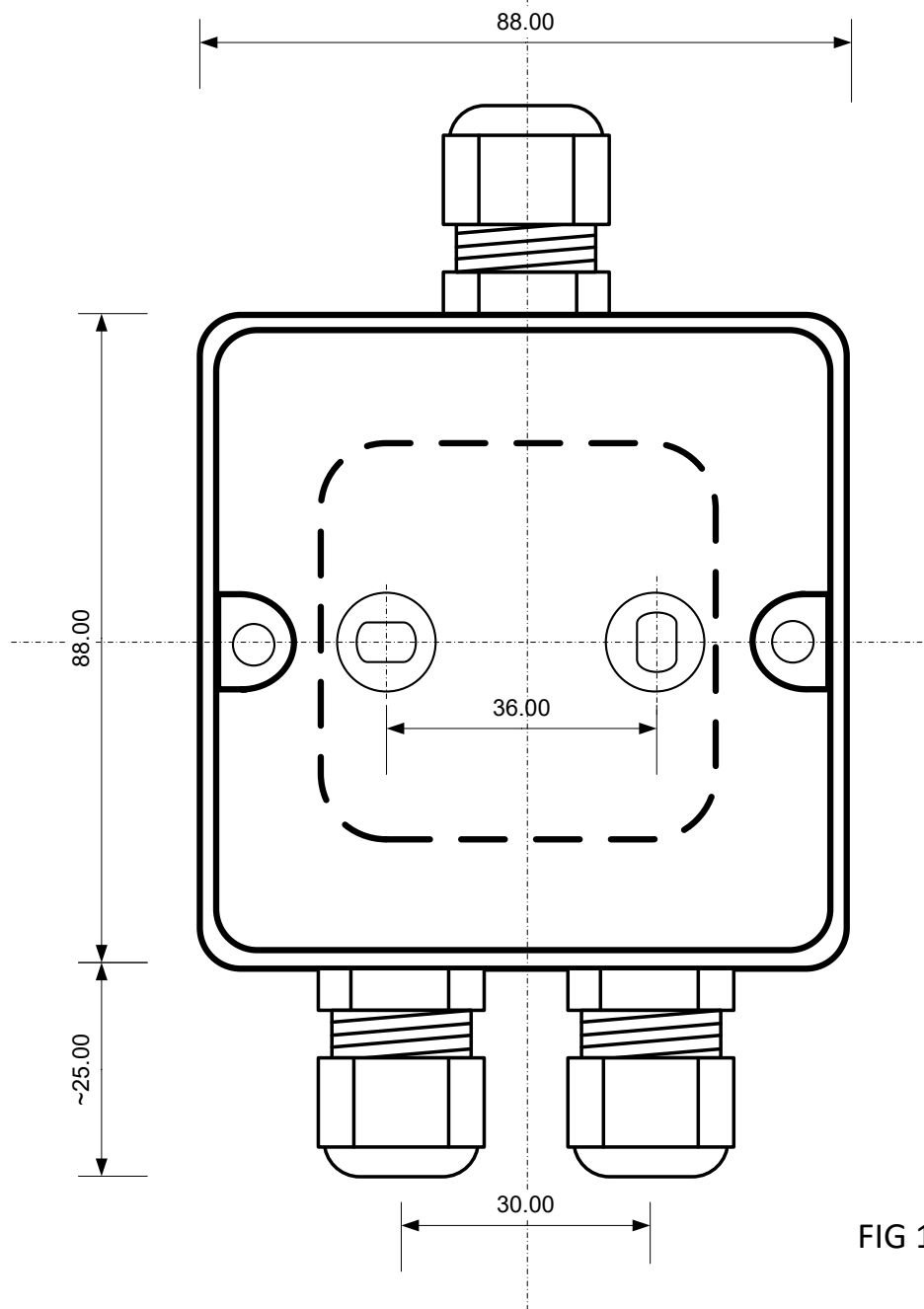

FIG 1.3 Wall Mounting
Template

All dimensions in mm

Fixing Instructions:

1. Fix the rear of the MAINSLINK enclosure to the wall using the template above.
2. Ensure that all fixing screws are screwed flush to the enclosure.
3. Ensure that the screw covers are put in place. These ensure water proofing and insulate the PCB from the wall fixing screws. Screw Covers are found inside the rear of the enclosure.
4. Once the enclosure is fixed to the wall, screw the on front plate with the PCB in place.

Pairing a Receiver

NOTE: MAINSLINK Systems are supplied pre-paired. This process is described for advanced use only.

To pair the MAINSLINK-RX it must have a 230Vac supply connected.

1. Briefly place a magnet on the receiver by the MAINSLINK-RX as shown in FIG1.3.

This will put the system in learn mode.

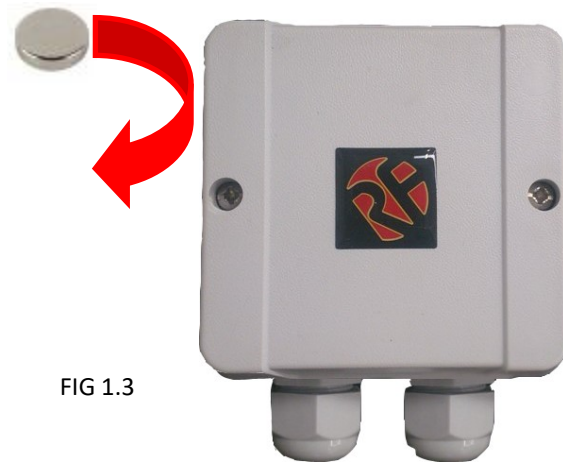

FIG 1.3



2. When the receiver is in learn mode you will need to pair the transmitter within 10 seconds. To do this you must apply the 230Vac supply to the transmitter for 2 seconds and then turn it off.

3. Allow 15 seconds for the receiver to return to normal operation.

Erasing a Receiver

To erase all transmitters from the MAINSLINK-RX hold a magnet beside the learn switch for 10 seconds as shown in FIG 1.4.

NOTE: You cannot erase individual MAINSLINK-TX units.

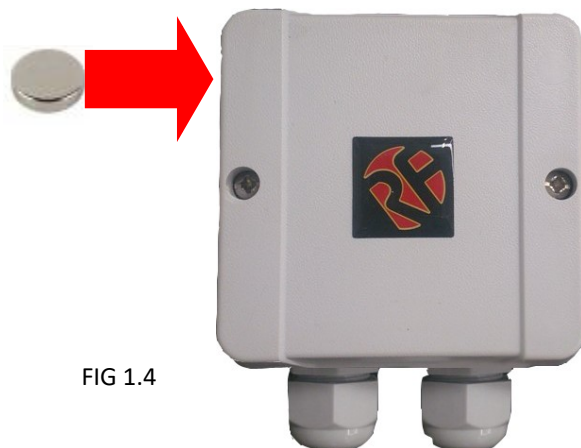

FIG 1.4

Power Supply

The MAINSLINK is designed to operate between 110-230V in a fixed installation. Before removing the cover on either Transmitter or Receiver ensure that the mains input supply is isolated. Maintenance to the product that involves removal of the cover should only be carried out by a competent person or qualified electrician.

Operational Features and Advanced Instructions:

System Communication:

The MAINSLINK-TX transmitter automatically sends its status to the MAINSLINK-RX Receiver every time the SWITCHED LIVE wired into the TX becomes active. The MAINSLINK-RX receiver then mirrors the MAINSLINK-TX Transmitters' status.

Fail safe "Watchdog" feature

The Watchdog Feature improved reliability for the system.

When enabled, the MAINSLINK-TX automatically sends a background signal every 20 secs when its input is active.

The MAINSLINK-RX expects to receive this background watchdog signal. If it fails to receive one watchdog signal within a two minute period it will deactivate its output.

Multiple system operation:

Each MAINSLINK transmitter is uniquely coded, this means that no two systems will cross operate by default. If multiple transmitters or receivers are required to work together the MAINSLINK can be programmed to work together.

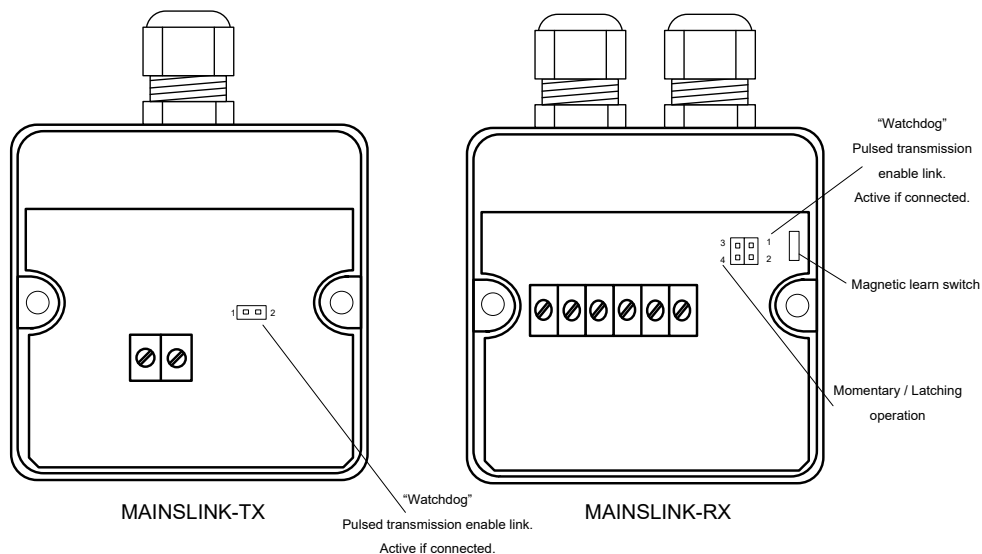

One to Many Operation:

To pair a transmitter of receivers together the following process must be done:

- 1) Apply power to MAINSLINK-RX (once powered do not touch the PCB!)
- 2) Pass a magnet close to the magnetic learn switch, you should see an LED start to flash
- 3) Whilst this LED is flashing apply power to the MAINSLINK-TX and then power unit off
- 4) MAINSLINK-RX will stop flashing its LED
- 5) Your MAINSLINK-TX will now operate your MAINSLINK-RX
- 6) Pairing complete

Advanced Tip: It is not recommended to have too many systems operating in one location however, as effective operation could become compromised.

Technical Specification:

Dimensions: 88 x 88 x 54mm (see page 3)
Storage Temperature: -10 to +70° Celsius.
Operating Temperature: 0 to +50° Celsius.

Electrical Characteristics:

	Min	Typical	Max	Units
Supply Voltage TX/RX:	100	230	250	Vac
Quiescent Current: TX: (negligible @230V <0.1uA) RX: (Relay not operating - negligible @230V <0.1uA)		~ 0.1 (relay operating)		uA mA
Operating Frequency*		869.50		MHz
Maximum switching load (RX)		1000		W
Time delay from Tx on switch to Rx Relay operation:	50	50	3000	mS
Time delay from Tx sw relax to Rx Relay release:	50	50	3000	mS

*MAINSLINK uses RF Solutions APLHA range of radio modules. For further transmission information see the relevant datasheet.

RF Solutions Ltd. Recycling Notice

Meets the following EC Directives:

DO NOT

Discard with normal waste, please recycle.

ROHS Directive 2002/95/EC

Specifies certain limits for hazardous substances.



WEEE Directive 2002/96/EC

Waste electrical & electronic equipment. This product must be disposed of through a licensed WEEE collection point. RF Solutions Ltd., fulfills its WEEE obligations by membership of an approved compliance scheme.



Waste Batteries and Accumulators Directive 2006/66/EC

Where batteries are fitted, before recycling the product, the batteries must be removed and disposed of at a licensed collection point.

Environment Agency producer registration number: WEE/JB0104WV.

Disclaimer:

Whilst the information in this document is believed to be correct at the time of issue, RF Solutions Ltd does not accept any liability whatsoever for its accuracy, adequacy or completeness. No express or implied warranty or representation is given relating to the information contained in this document. RF Solutions Ltd reserves the right to make changes and improvements to the product(s) described herein without notice. Buyers and other users should determine for themselves the suitability of any such information or products for their own particular requirements or specification(s). RF Solutions Ltd shall not be liable for any loss or damage caused as a result of user's own determination of how to deploy or use RF Solutions Ltd's products. Use of RF Solutions Ltd products or components in life support and/or safety applications is not authorised except with express written approval. No licences are created, implicitly or otherwise, under any of RF Solutions Ltd's intellectual property rights. Liability for loss or damage resulting or caused by reliance on the information contained herein or from the use of the product (including liability resulting from negligence or where RF Solutions Ltd was aware of the possibility of such loss or damage arising) is excluded. This will not operate to limit or restrict QuasarUK Ltd's liability for death or personal injury resulting from its negligence.